

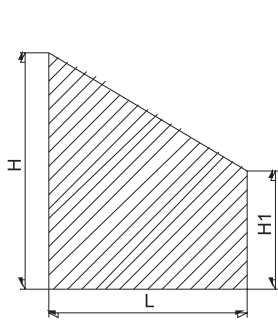

# SHAPES CATALOGUE

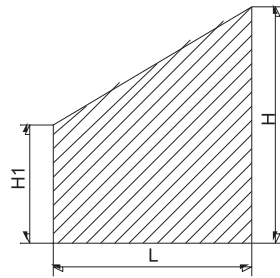

**1**  
Surcharge 40%



**2**  
Surcharge 40%

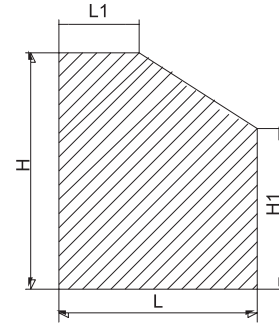

**3**  
Surcharge 40%

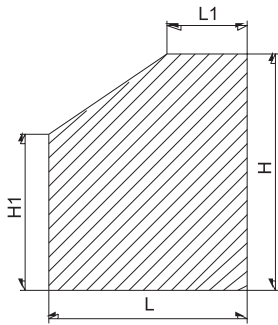

**4**  
Surcharge 40%

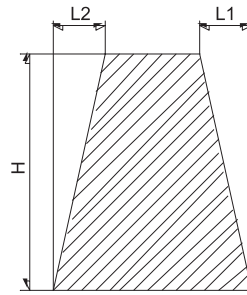

**5**  
Surcharge 80%

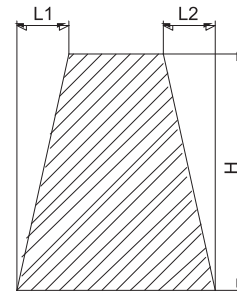

**6**  
Surcharge 80%

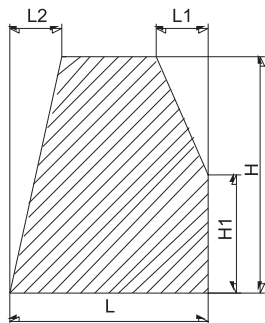

**7**  
Surcharge 80%

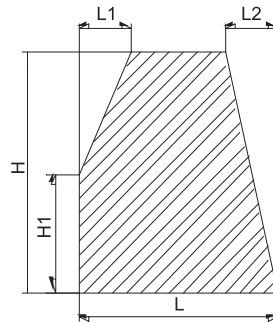

**8**  
Surcharge 80%

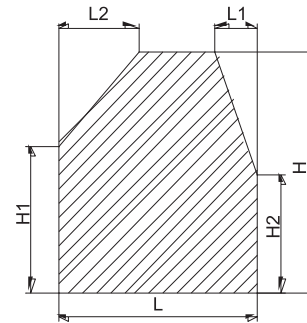

**9**  
Surcharge 80%

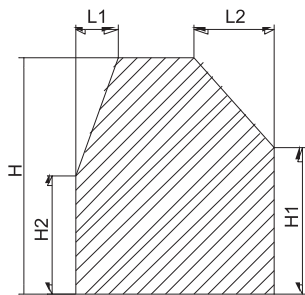

**10**  
Surcharge 80%

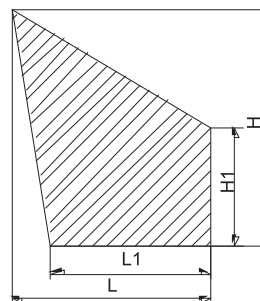

**11**  
Surcharge 80%

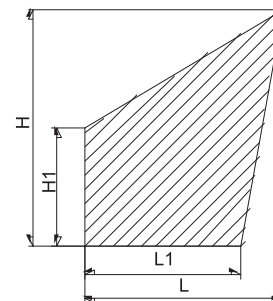

**12**  
Surcharge 80%

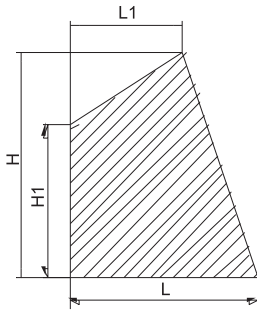

**13**  
Surcharge 80%

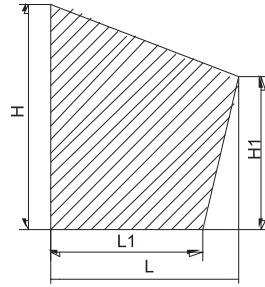

**14**  
Surcharge 80%

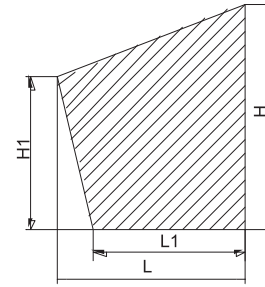

**15**  
Surcharge 80%

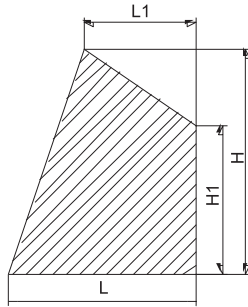

**16**  
Surcharge 80%

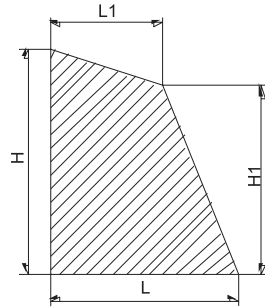

**17**  
Surcharge 80%

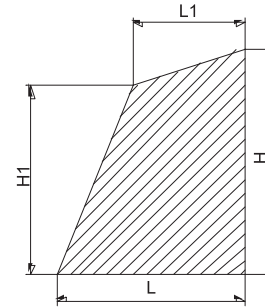

**18**  
Surcharge 80%

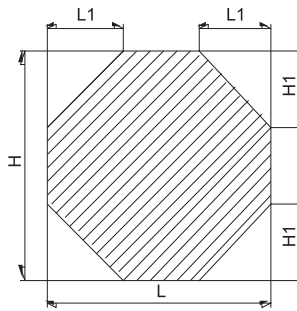

**19**  
Surcharge 160%

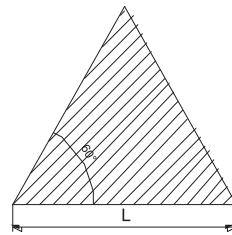

**20**  
Surcharge 80%

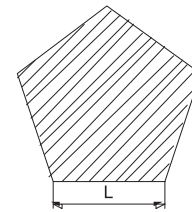

**21**  
Surcharge 160%

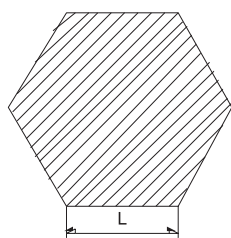

**22**  
Surcharge 160%

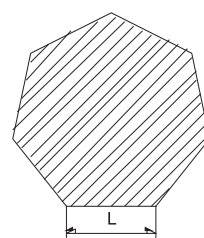

**23**  
Surcharge 240%

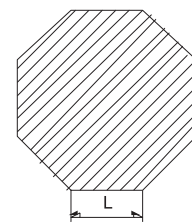

**24**  
Surcharge 160%

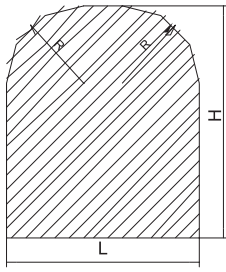

**25**  
Surcharge 60%

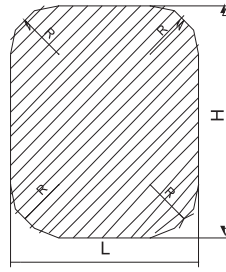

**26**  
Surcharge 120%

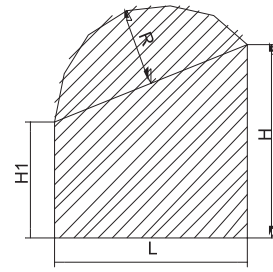

**27**  
Surcharge 80%

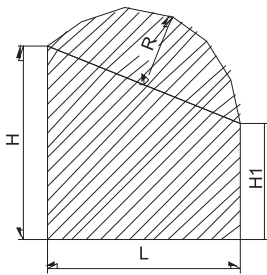

**28**  
Surcharge 80%

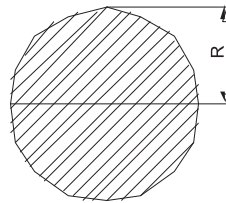

**29**  
Surcharge 120%

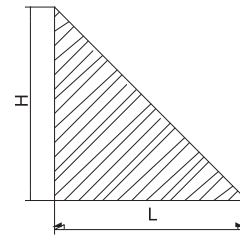

**33**  
Surcharge 40%

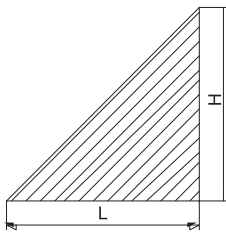

**34**  
Surcharge 40%

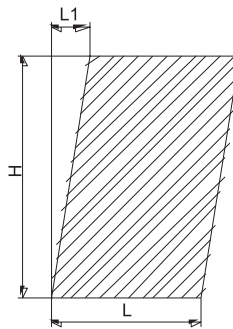

**37**  
Surcharge 80%

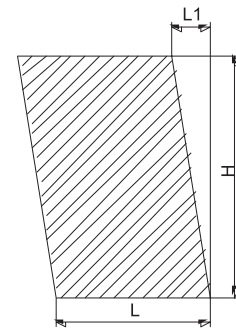

**38**  
Surcharge 80%

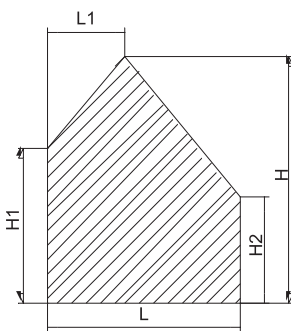

**40**  
Surcharge 80%

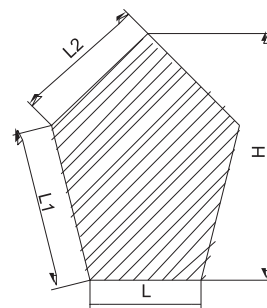

**41**  
Surcharge 160%

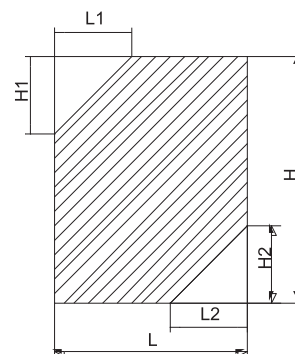

**42**  
Surcharge 80%

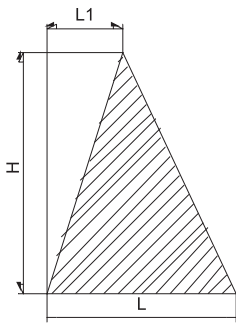

**43**  
Surcharge 80%

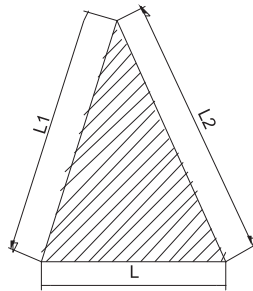

**44**  
Surcharge 80%

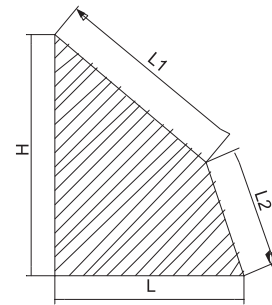

**45**  
Surcharge 80%

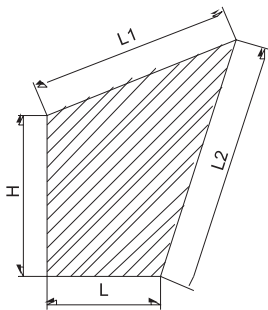

**46**  
Surcharge 80%

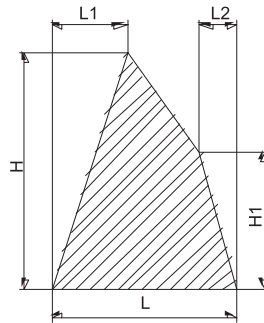

**47**  
Surcharge 120%

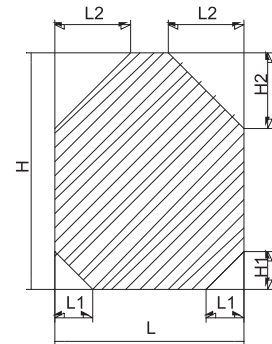

**48**  
Surcharge 160%

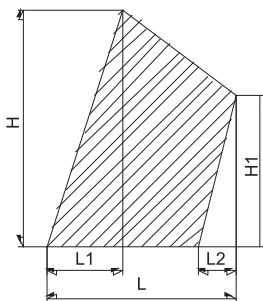

**49**  
Surcharge 120%

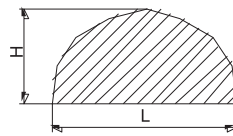

**50**  
Surcharge 80%

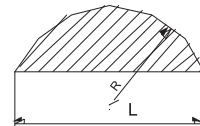

**51**  
Surcharge 80%

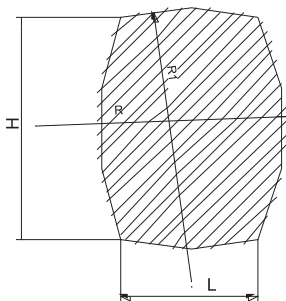

**52**  
Surcharge 240%

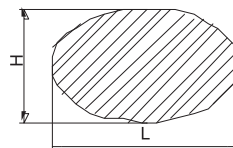

**53**  
Surcharge 120%

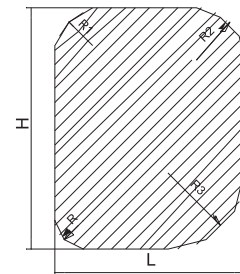

**55**  
Surcharge 240%

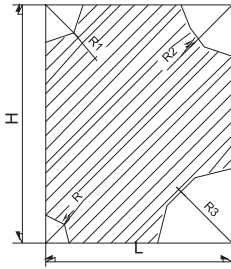

**56**  
Surcharge 240%

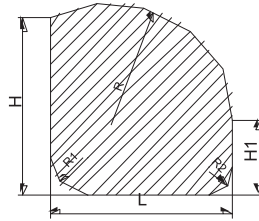

**57**  
Surcharge 200%

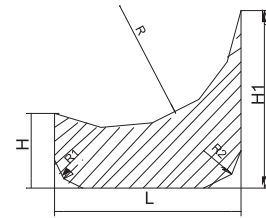

**58**  
Surcharge 240%

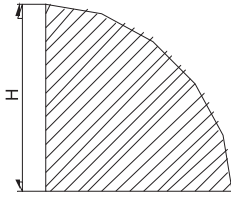

**59**  
Surcharge 80%

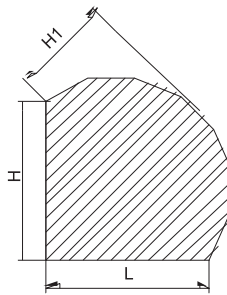

**60**  
Surcharge 80%

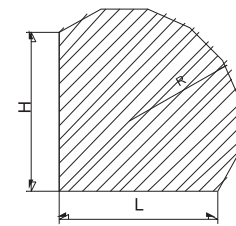

**61**  
Surcharge 80%

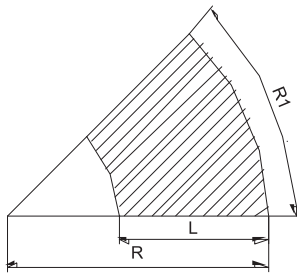

**62**  
Surcharge 200%

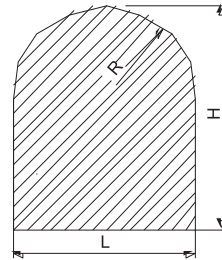

**100**  
Surcharge 80%

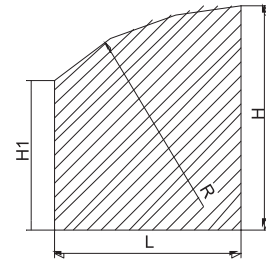

**101**  
Surcharge 80%

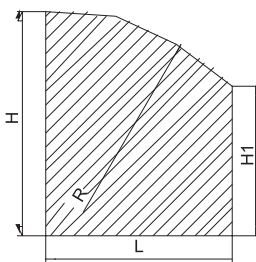

**102**  
Surcharge 80%

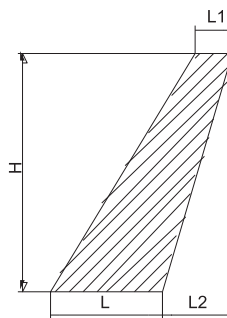

**103**  
Surcharge 80%

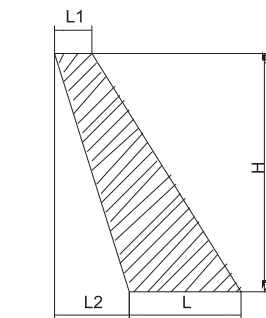

**104**  
Surcharge 80%